



SMD PCB terminal block; Push-button; 1.5 mm²; Pin spacing 6 mm; 1-pole; Push-in CAGE CLAMP®; in tape-and-reel packaging

Item No.: 2061-601/998-404



SMD PCB terminal block; Push-button; 1.5 mm²; Pin spacing 6 mm; 1-pole; Push-in CAGE CLAMP®; in tape-and-reel packaging

Marking

RoHS ✓
Compliant

Business data

Supplier	WAGO
Item no.	2061-601/998-404
GTIN / EAN	4055143278065
Content	1
Order amount	900
Customer item number	

Notes

Item description: SMD PCB terminal blocks with Push-in CAGE CLAMP® connection and push-buttons Just 5.6 mm tall Push-in termination of solid and ferruled conductors Push-buttons simplify insertion/removal of all conductor types Available in tape-and-reel packaging for automated assembly

Technical data

Miscellaneous

No. of poles	1
Pin spacing	6 mm (0.24 in)

Technical data	
Total number of connection points	1
Total number of potentials	1
Color	white
Ratings per	IEC/EN 60664-1
Rated voltage (III / 3) [V]	250 [V]
Rated impulse voltage (III / 3) [kV]	4 [kV]
Rated voltage (III/2) [V]	320 [V]
Rated impulse voltage (III / 2) [kV]	4 [kV]
Rated voltage (II / 2) [V]	630 [V]
Rated impulse voltage (II / 2) [kV]	4 [kV]
Rated current [A]	17.5 [A]
Legend for ratings	(III / 2) Overvoltage category III /
Number of connection objects	1
Number of levels	1
Connection technology	Push-in CAGE CLAMP®
Number of connection points connector	1
Actuation type	Operating lever
Solid conductor	0.5 ... 1.5 mm ² / 20 ... 16 AWG
Fine-stranded conductor	0.5 ... 1.5 mm ² / 20 ... 16 AWG
Fine-stranded conductor with ferrule with plastic collar	0.5 ... 0.75 mm ² / ...
Fine-stranded conductor with ferrule without plastic collar	0.5 ... 0.75 mm ² / ...
Strip length	7 ... 10 mm / 0.28 ... 0.39 Inch
Conductor entry angle to the PCB [°]	0 [°]
Solder pad dimensions [mm]	6.5 x 2.1 [mm]
Reel diameter of tape-and-reel packaging [mm]	330 [mm]
Tape width [mm]	24 [mm]
Material group	I
Insulating material	Polyphthalamide (PPA GF)
Flammability class per UL94	V0
Limit temperature range	-60 ... 105 C
Contact material	Copper alloy
Contact plating	tin-plated
Weight [g]	0.54 [g]
Width	5.7 mm / 0.224 Inch

Printview: SMD PCB terminal block; Push-button; 1.5 mm²; Pin spacing 6 mm; 1-pole; Push-in CAGE CLAMP®; in tape-and-reel packaging - Item No.: 2061-601/998-404

Technical data

<i>Height</i>	<i>5.6 mm / 0.22 Inch</i>
<i>Height from the surface</i>	<i>5.6 mm / 0.22 Inch</i>
<i>Depth</i>	<i>15.8 mm / 0.622 Inch</i>

Images & drawings



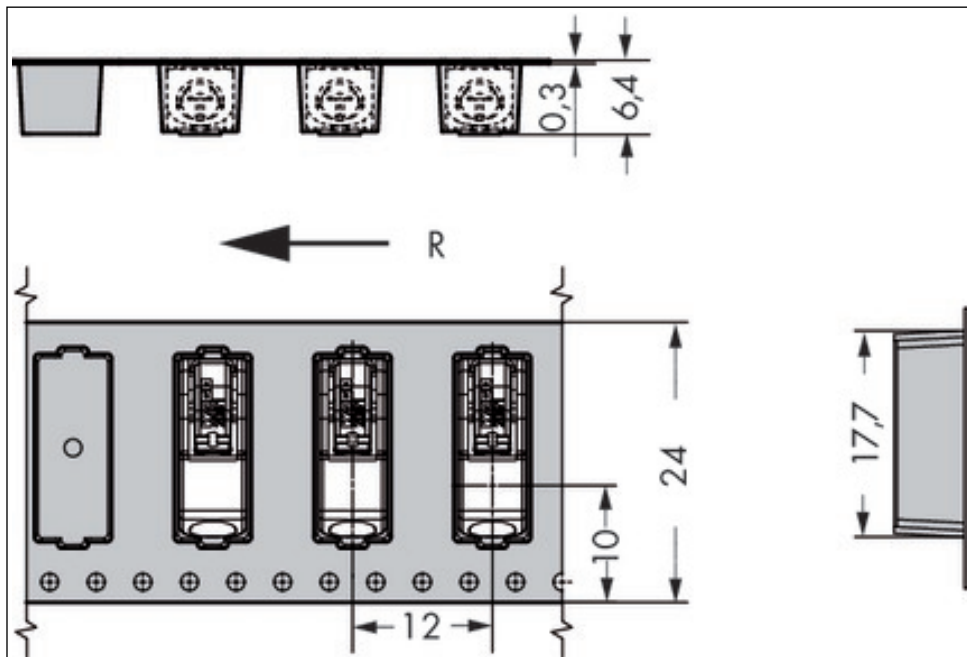
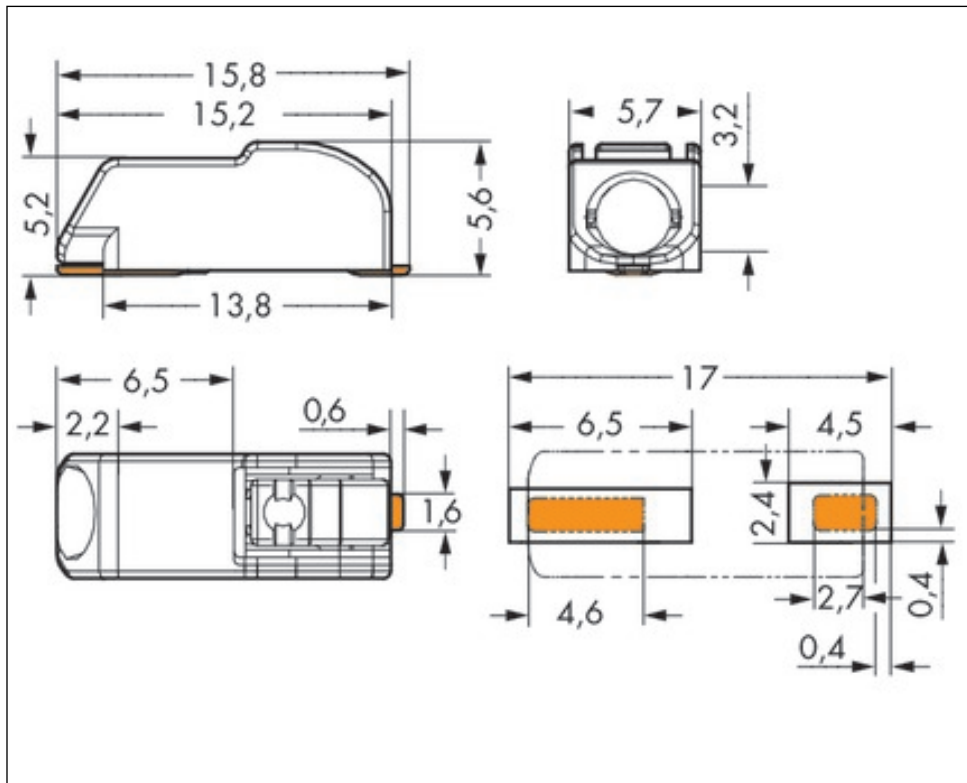

Address

WAGO Kontakttechnik GmbH & Co. KG

Hansastr. 27

32423 Minden

Telefon: 0571/887-0

Fax: 0571/887-169

<http://www.wago.com>

© WAGO Kontakttechnik GmbH & Co. KG

Technische Änderungen und Irrtümer vorbehalten.